

Data Sheet



Article number: 432000065

Description: Rota-fix shaft-hub connection A 65x95
Steel

Note: Not self centering. Medium-high torques.

Measures

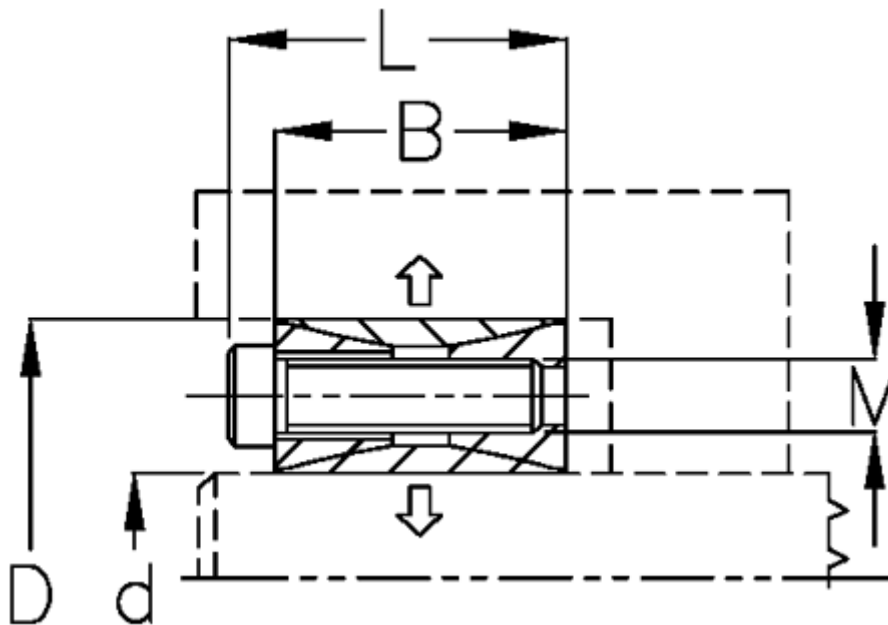

B mm	= 24
d H8 mm	= 6595
D mm	= 95
Fit tolerance	= Aksel k11-h11, Nav N11-H11
F kN torque	= 100.0
L mm	= 32
M mm	= M8
P N/mm ² surface pressure on shaft/hub	= 143

Surface roughness	=
T N m torque	=
Ts N m bolt tightening torque	=